

EN

User manual

Microwave combi-oven

# USER MANUAL

ZKC44500

**ZANUSSI**

# Contents

---

Safety information _____	2	Helpful hints and tips _____	14
Safety instructions _____	4	Care and cleaning _____	27
Product description _____	6	What to do if... _____	28
Before first use _____	7	Installation _____	29
Daily use _____	7	Environment concerns _____	32
Microwave mode _____	9	GREAT BRITAIN & IRELAND - Guarantee/	
Clock functions _____	12	Customer Service _____	33
Using the accessories _____	13	European Guarantee _____	34
Additional functions _____	13		

Subject to change without notice.

## Safety information

---

Before the installation and use of the appliance, carefully read the supplied instructions. The manufacturer is not responsible if an incorrect installation and use causes injuries and damages. Always keep the instructions with the appliance for future reference.

### Children and vulnerable people safety

 **Warning!** Risk of suffocation, injury or permanent disability.

- This appliance can be used by children aged from 8 years and above and persons with reduced physical, sensory or mental capabilities or lack of experience and knowledge if they are supervised by an adult or a person who is responsible for their safety.
- Do not let children play with the appliance.
- Keep all packaging away from children.
- Keep children and pets away from the appliance when it operates or when it cools down. Accessible parts are hot.
- If the appliance has a child safety device, we recommend that you activate it.
- Cleaning and user maintenance shall not be made by children without supervision.
- Keep the appliance and its cord out of reach of children less than 8 years.

## General Safety

- Only a qualified person must install this appliance and replace the cable.
- Internally the appliance becomes hot when in operation. Do not touch the heating elements that are in the appliance. Always use oven gloves to remove or put in accessories or ovenware.
- Do not use a steam cleaner to clean the appliance.
- Before maintenance cut the power supply.
- If the door or door seals are damaged, the appliance must not be operated until it has been repaired by a competent person.
- Only a competent person can carry out any service or repair operation that involves the removal of a cover which gives protection against exposure to microwave energy.
- Do not heat liquids and other foods in sealed containers. They are liable to explode.
- Only use utensils that are suitable for use in microwave ovens.
- When heating food in plastic or paper containers, keep an eye on the appliance due to the possibility of ignition.
- The appliance is intended for heating food and beverages. Drying of food or clothing and heating of warming pads, slippers, sponges, damp cloth and similar may lead to risk of injury, ignition or fire.
- If smoke is emitted, switch off or unplug the appliance and keep the door closed in order to stifle any flames.
- Microwave heating of beverages can result in delayed eruptive boiling. Care must be taken when handling the container.
- The contents of feeding bottles and baby food jars shall be stirred or shaken and the temperature checked before consumption, in order to avoid burns.
- Eggs in their shell and whole hard-boiled eggs should not be heated in the appliance since they may explode, even after microwave heating has ended.

- The appliance should be cleaned regularly and any food deposits removed.
- Failure to maintain the appliance in a clean condition could lead to deterioration of the surface that could adversely affect the life of the appliance and possibly result in a hazardous situation.
- Do not use harsh abrasive cleaners or sharp metal scrapers to clean the glass door since they can scratch the surface, which may result in shattering of the glass.
- To remove the shelf supports first pull the front of the shelf support and then the rear end away from the side walls. Install the shelf supports in the opposite sequence.
- Ensure that the appliance is switched off before replacing the lamp to avoid the possibility of electric shock.



## Safety instructions

### Installation



**Warning!** Only a qualified person must install this appliance.

- Remove all the packaging.
- Do not install or use a damaged appliance.
- Obey the installation instruction supplied with the appliance.
- Always be careful when you move the appliance because it is heavy. Always wear safety gloves.
- Do not pull the appliance by the handle.
- Keep the minimum distance from the other appliances and units.
- Make sure that the appliance is installed below and adjacent safe structures.
- The sides of the appliance must stay adjacent to appliances or to units with the same height.

### Electrical connection



**Warning!** Risk of fire and electrical shock.

- All electrical connections should be made by a qualified electrician.

- The appliance must be earthed.
- Make sure that the electrical information on the rating plate agrees with the power supply. If not, contact an electrician.
- Always use a correctly installed shockproof socket.
- Do not use multi-plug adapters and extension cables.
- Make sure not to cause damage to the mains plug and to the mains cable. Contact the Service or an electrician to change a damaged mains cable.
- Do not let mains cables to come in touch with the appliance door, specially when the door is hot.
- The shock protection of live and insulated parts must be fastened in such a way that it cannot be removed without tools.
- Connect the mains plug to the mains socket only at the end of the installation. Make sure that there is access to the mains plug after the installation.
- If the mains socket is loose, do not connect the mains plug.

- Do not pull the mains cable to disconnect the appliance. Always pull the mains plug.
- Use only correct isolation devices: line protecting cut-outs, fuses (screw type fuses removed from the holder), earth leakage trips and contactors.
- The electrical installation must have an isolation device which lets you disconnect the appliance from the mains at all poles. The isolation device must have a contact opening width of minimum 3 mm.

## Use

 **Warning!** Risk of injury, burns or electric shock or explosion.

- Use this appliance in a household environment.
- Do not change the specification of this appliance.
- Make sure that the ventilation openings are not blocked.
- Do not let the appliance stay unattended during operation.
- Deactivate the appliance after each use.
- Be careful when you open the appliance door while the appliance is in operation. Hot air can release.
- Do not operate the appliance with wet hands or when it has contact with water.
- Do not apply pressure on the open door.
- Do not use the appliance as a work surface or as a storage surface.
- Always keep the appliance door closed when the appliance is in operation.
- Open the appliance door carefully. The use of ingredients with alcohol can cause a mixture of alcohol and air.
- Do not let sparks or open flames to come in contact with the appliance when you open the door.
- Do not put flammable products or items that are wet with flammable products in, near or on the appliance.

 **Warning!** Risk of damage to the appliance.

- To prevent damage or discoloration to the enamel:
  - do not put ovenware or other objects in the appliance directly on the bottom.
  - do not put aluminium foil directly on the bottom of the appliance.
  - do not put water directly into the hot appliance.
  - do not keep moist dishes and food in the appliance after you finish the cooking.
  - be careful when you remove or install the accessories.
- Discoloration of the enamel has no effect on the performance of the appliance. It is not a defect in the sense of the warranty law.
- Use a deep pan for moist cakes. Fruit juices cause stains that can be permanent.

## Care and Cleaning

 **Warning!** Risk of injury, fire or damage to the appliance.

- Before maintenance, deactivate the appliance and disconnect the mains plug from the mains socket.
- Make sure the appliance is cold. There is the risk that the glass panels can break.
- Replace immediately the door glass panels when they are damaged. Contact the Service.
- Clean regularly the appliance to prevent the deterioration of the surface material.
- Remaining fat or food in the appliance can cause fire.
- Clean the appliance with a moist soft cloth. Only use neutral detergents.
- If you use an oven spray, obey the safety instructions on the packaging.
- Do not clean the catalytic enamel (if applicable) with any kind of detergent.

## Internal light

- The type of light bulb or halogen lamp used for this appliance, is only for household appliances. Do not use it for house lighting.

 **Warning!** Risk of electrical shock.

- Before replacing the lamp, disconnect the appliance from the power supply.

- Only use lamps with the same specifications.

## Disposal

**Warning!** Risk of injury or suffocation.

- Disconnect the appliance from the mains supply.

## Product description

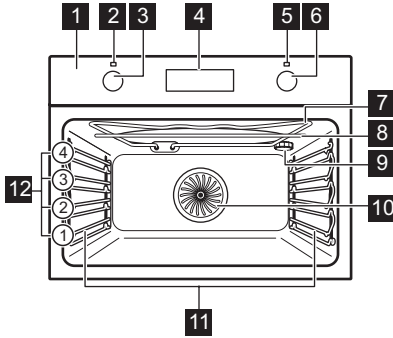

- 1** Control panel
- 2** Power lamp / symbol / indicator
- 3** Knob for the oven functions
- 4** Electronic programmer
- 5** Temperature / microwave power lamp / symbol / indicator
- 6** Knob for the temperature / microwave power
- 7** Grill and heating element
- 8** Microwave generator
- 9** Lamp
- 10** Fan and heating element
- 11** Shelf support, removable
- 12** Shelf positions

## Accessories

**Caution!** Do not use the baking tray or deep pan (if applicable) with the Microwave function.

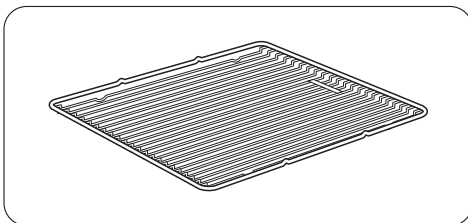

### Wire shelf

For cookware, cake tins, roasts.

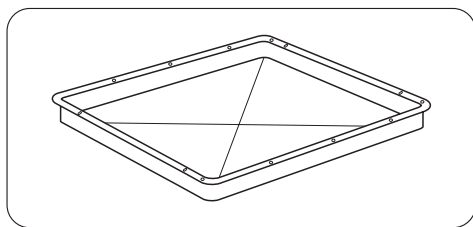

## Baking tray

For cakes and biscuits.

## Before first use

**Warning!** Refer to the Safety chapters.

### Initial Cleaning

- Remove all parts from the appliance.
- Clean the appliance before first use.

**Important!** Refer to chapter "Care and Cleaning".

### Setting the time

After the first connection to the mains, all symbols in the display are on for some seconds. For the subsequent few seconds the display shows the software version.

After the software version goes off, the display shows **hr** and "**12:00**". "**12**" flashes.

1. Press **+** or **-** to set the current hour.
2. Press **⌚** to confirm (necessary only for the first setting. Later the new time will be saved automatically after 5 seconds).

The display shows **min** and the set hour. "**00**" flashes.

3. Press **+** or **-** to set the current minutes.
4. Press **⌚** to confirm (necessary only for the first setting. Later the new time will be saved automatically after 5 seconds). The Temperature / Time display shows the new time.

### Changing the time of day

You can change the time of day only if the oven is off.

Press **⌚**. The set time and symbol **⌚** flash in the display. To set a new time, use the procedure "Setting the time".

## Daily use

**Warning!** Refer to the Safety chapters.











### Activating a heating function

1. Turn the knob for the oven function to select an oven function.
2. Turn the knob for the temperature / microwave power to set a temperature.
3. To deactivate the appliance, turn the knob for the oven function to the off position ("**0**").

**i** **Knob symbol, indicator or lamp (depends on the model - refer to the product description):**

- The indicator comes on when the oven heats up.
- The lamp comes on when the appliance operates.
- The symbol shows whether the knob controls one of the cooking zones, the oven functions or the temperature.

## Oven Functions

Oven function	Application
 Light	To activate the lamp without a cooking function.
 Microwave	Creates the heat directly in the food. Use it to heat pre-prepared meals and drinks, to defrost meat or fruit, and to cook vegetables and fish.
 True Fan Cooking	To bake maximum on 2 shelf positions at the same time and to dry food. Set the temperature 20 - 40 °C lower than for Conventional Cooking.
 Pizza Setting	To bake food on 1 shelf position for a more intensive browning and a crispy bottom. Set the temperature 20 - 40 °C lower than for Conventional Cooking.
 Conventional Cooking	To bake and roast on 1 shelf position.
 Bottom Heat	To bake cakes with crispy or crusty bottoms and to preserve food.
 Defrost	To defrost frozen food.
 Grilling	To grill flat food and to toast.
 Fast Grilling	To grill flat food in large quantities and to toast.
 Turbo Grilling	To roast larger joints of meat or poultry on 1 shelf position. Also to gratinate and to brown.

## Display

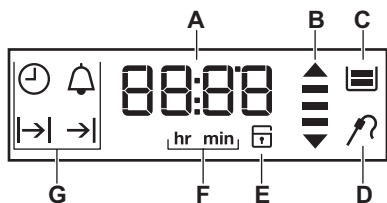

- A) Timer
- B) Heat-up and residual heat indicator
- C) Water drawer (selected models only)
- D) Core temperature sensor (selected models only)
- E) Door lock (selected models only)
- F) Hours / minutes
- G) Clock functions

## Buttons

Button	Function	Description
	CLOCK	To set a clock function.



Button	Function	Description
—, +	MINUS, PLUS	To set the time.
	MICROWAVE	To set the MICROWAVE.
°C	TEMPERATURE	To check the oven temperature or the temperature of the Core Temperature Sensor (if applicable). Use only while an oven function is in operation.







### Heat-up / Residual heat indicator

If you activate an oven function, the bars in the display  come on one by one. The bars show

that the oven temperature increases or decreases.

## Microwave mode

### Setting the Microwave function

- Turn the knob for the oven functions to select a microwave function . The display shows a default microwave power and then a default value of the Duration function.
- Press  and turn the knob for the temperature / microwave power   to change the microwave power settings. The power settings changes in 100 W steps.
- Press  and then  /  to change the Duration settings. The appliance automatically starts to operate after few seconds.
- When the set time ends, an acoustic signal sounds and the Microwave function deactivates automatically.
- Turn the knob for the oven functions to off position (“0”).

 **Caution!** Do not let the appliance operate when there is no food in it.

 **When the Microwave function is running you can:**

- change the power settings.
- check the power settings. Press .

### Setting the Combi function

- Turn the function knob to select an oven function.

- The display shows a default temperature.
- Change the temperature.
- Activate the Microwave function. Refer to “Setting the Microwave function”.
- When the set time ends, an acoustic signal sounds and the oven function and Microwave function deactivates automatically.
- Turn the function knob to off position (“0”).

### Microwave

#### Information about operation

##### General:

- After you deactivate the appliance, let the food stand for some minutes (refer to “Microwave Tables: standing time”).
- Remove the aluminium foil packaging, metal containers, etc. before you prepare the food.

##### Cooking:

- Do not use the baking tray or deep pan (if applicable) with the Microwave function.
- If possible, cook food covered with material suitable for use in the microwave. Only cook food without a cover if you want to keep a crust.
- Do not overcook the dishes by setting the power and time too high. The food can dry out, burn or catch fire in some places.
- Do not use the appliance to cook eggs in their shells and snails, because they can burst. With fried eggs, pierce the yolks first.

- Prick food with "skin" or "peel", such as potatoes, tomatoes, sausages, with a fork several times before cooking so that the food does not burst.
- For chilled or frozen food, set a longer cooking time.
- Dishes which contain sauce must be stirred from time to time.
- Vegetables that have a firm structure, such as carrots, peas or cauliflower, must be cooked in water.
- Turn larger pieces after half the cooking time.
- If possible, cut vegetables into similar-sized pieces.
- Use flat, wide dishes.
- Do not use cookware made of porcelain, ceramic or earthenware with small holes, e. g. on handles or unglazed bottoms. Moisture going into the holes can cause the cookware to crack when it is heated.
- The bottom glass (if applicable) is a work space for heating food or liquids. It is necessary for the operation of the microwave oven.
- Always put the glass stick in the container when you heat liquids, in order to prevent overcooking or splashing.

### Defrosting meat, poultry, fish:

- Put the frozen, unwrapped food on a small upturned plate with a container below it, or

on a defrosting rack or plastic sieve so that the defrosting liquid can run off.

- Turn the food after half the defrosting time. If possible, divide and then remove the pieces that have started to defrost.

### Defrosting butter, portions of gâteau, quark:

- Do not fully defrost in the appliance, but let them defrost at room temperature. This gives a more even result. Fully remove all metal or aluminium packaging or parts before defrosting.

### Defrosting fruit, vegetables:

- Do not fully defrost fruit and vegetables, which are to be further prepared while raw, in the appliance. Let them defrost at room temperature.
- You can use a higher microwave power to cook fruit and vegetables without defrosting them first.

### Ready meals:

- Ready meals in metal packaging or plastic trays with metal covers can only be defrosted or heated in the microwave if they are expressly designated as suitable for use in the microwave.
- You must follow the manufacturer's instructions printed on the packaging (e. g. remove the metal cover and pierce the plastic film).

### Suitable cookware and materials

Cookware / Material	Microwave			Grilling ▼▼▼▼
	Defrosting	Heating	Cooking	
Ovenproof glass and porcelain (with no metal components, e. g. Pyrex, heat-proof glass)	X	X	X	X
Non-ovenproof glass and porcelain <sup>1)</sup>	X	--	--	--
Glass and glass ceramic made of ovenproof/frost-proof material (e. g. Arcoflam), grill shelf	X	X	X	X
Ceramic <sup>2)</sup> , earthenware <sup>2)</sup>	X	X	X	--
Heat-resistant plastic up to 200 °C <sup>3)</sup>	X	X	X	--
Cardboard, paper	X	--	--	--
Clingfilm	X	--	--	--

Cookware / Material	Microwave			Grilling ▼▼▼
	Defrosting	Heating	Cooking	
Roasting film with microwave safe closure <sup>3)</sup>	X	X	X	--
Roasting dishes made of metal, e. g. enamel, cast iron	--	--	--	X
Baking tins, black lacquer or silicon-coated <sup>3)</sup>	--	--	--	X
Baking tray	--	--	--	X
Browning cookware, e. g. Crisp pan or Crunch plate	--	X	X	--
Ready meals in packaging <sup>3)</sup>	X	X	X	X

1) With no silver, gold, platinum or metal plating/decorations

2) Without quartz or metal components, or glazes which contain metals

3) You must follow the manufacturer's instructions about the maximum temperatures.

### X suitable

-- not suitable

### Other things to think about...

- Food items have different shapes and qualities. They are prepared in different quantities. Because of this, the necessary time and power for defrosting, heating or cooking can vary. As a rough guide: **double the quantity = almost double the time.**
- The microwave creates the heat directly in the food. Because of this, all places cannot

be heated at the same time. You must stir or turn the heated dishes, especially with larger quantities of food.

- The **standing time** is given in the tables. Let the food stand, in the appliance or outside it, so that the heat is distributed more equally.
- You get better results for rice if you use flat, wide dishes.





### Examples of cooking applications for power settings

The data in the table is for guidance only.

Power setting	Use
<ul style="list-style-type: none"> <li>1000 Watt</li> <li>900 Watt</li> <li>800 Watt</li> <li>700 Watt</li> </ul>	<ul style="list-style-type: none"> <li>Heating liquids</li> <li>Searing at the start of the cooking process</li> <li>Cooking vegetables</li> <li>Melting gelatine and butter</li> </ul>
<ul style="list-style-type: none"> <li>600 Watt</li> <li>500 Watt</li> </ul>	<ul style="list-style-type: none"> <li>Defrosting and heating frozen meals</li> <li>Heating one-plate meals</li> <li>Simmering stews</li> <li>Cooking egg dishes</li> </ul>
<ul style="list-style-type: none"> <li>400 Watt</li> <li>300 Watt</li> <li>200 Watt</li> </ul>	<ul style="list-style-type: none"> <li>Continuing to cook meals</li> <li>Cooking delicate food</li> <li>Heating baby food</li> <li>Simmering rice</li> <li>Heating delicate food</li> <li>Melting cheese</li> </ul>

Power setting	Use
<ul style="list-style-type: none"> <li>100 Watt</li> </ul>	<ul style="list-style-type: none"> <li>Defrosting meat, fish, bread</li> <li>Defrosting cheese, cream, butter</li> <li>Defrosting fruit and cakes (gateaux)</li> <li>Raising yeast dough</li> <li>Heating up cold dishes and drinks</li> </ul>













## Clock functions



SYMBOL	FUNCTION	DESCRIPTION
	MINUTE MINDER	To set a countdown time. This function has no effect on the operation of the oven. You can set the MINUTE MINDER at any time, also when the appliance is off.
	TIME OF DAY	To set, change or check the time of day. Refer to "Setting the time".
	DURATION	To set how long the appliance must operate. First set an oven function before you set this function.
	END	To set when the appliance must be deactivated. First set an oven function before you set this function. You can use Duration and End at the same time (Time Delay) to set the time when the appliance must be activated and then deactivated.

**i** Press  again and again to change the clock function.

**i** Press  to confirm the settings of the clock functions, or wait 5 seconds for the setting to be confirmed automatically.





### Setting the DURATION or END

- Press  again and again until the display shows  or .  or  flashes in the display.
- Press  or  to set the minutes.
- Press  to confirm.
- Press  or  to set the hour.
- Press  to confirm. An acoustic signal sounds for 2 minutes after the time ends.  or  symbol and time setting flash in the display. The oven stops.
- Press any button or open the oven door to stop the acoustic signal.

**i** If you press  when you set the hours for DURATION , the appliance goes to setting of the END  function.

### Setting the MINUTE MINDER

Use this to set a countdown (maximum 2 h 30 min). This function has no effect on the operation of the oven. You can set the MINUTE MINDER at any time, also if the appliance is off.

- Press  again and again until  and "00" flash in the display.
- Press  or  to set the MINUTE MINDER. At first the time is calculated in minutes and seconds. When the time you set is longer than 60 minutes, the symbol **hr** comes on the display. The appliance now calculates the time in hours and minutes.
- The MINUTE MINDER starts automatically after five seconds.

**i** After 90% of the set time, an acoustic signal sounds.

Press a button to stop the signal.

4. When the set time ends, an acoustic signal sounds for two minutes. "00:00" and 🔔 flash in the display.  
Press a button to stop the signal.

**i** If you set the MINUTE MINDER when the DURATION or END function operates, the symbol 🔔 comes on the display.

### Count Up Timer

Use the Count Up Timer to monitor how long the oven operates. It is on immediately when the oven starts to heat.

To reset the Count Up Timer, press and hold — and +.

**i** You cannot use the Count Up Timer when Duration or End function operates.

## Using the accessories

**⚠ Warning!** Refer to the Safety chapters.

### Inserting the accessories

#### Baking tray (if applicable):

Push the baking tray between the guide bars of the shelf support.

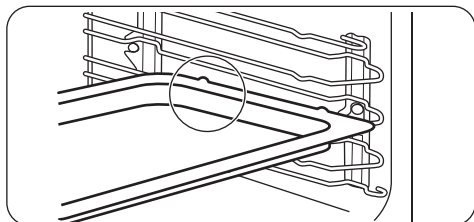

#### Wire shelf:

Push the shelf between the guide bars of the shelf support and make sure that the feet point down.

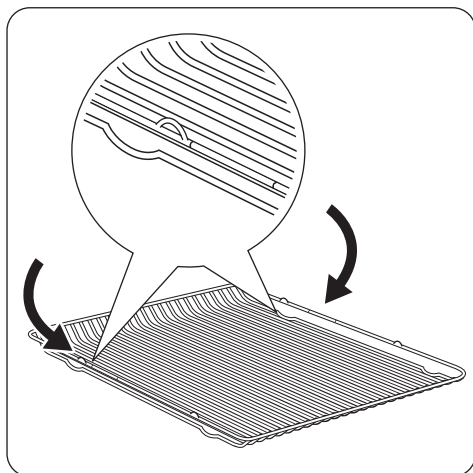

- All accessories have small indentations at the top of the right and left side to increase safety. The indentations are also anti-tip devices.
- The high rim around the shelf is a device which prevents cookware from slipping.

## Additional functions

### Child Lock

The Child Lock prevents an accidental operation of the appliance.

#### Activating and deactivating the Child Lock function:

1. Do not set an oven function.



2. Press and hold ⚠ and + at the same time for 2 seconds.
3. An acoustic signal sounds. SAFE comes on / goes out on the display (when you activate or deactivate the Child Lock).

**i** SAFE comes on the display when you turn a knob or press a button.

## Function Lock

The Function Lock prevents an accidental change of the oven function. You can activate the Function Lock function only when the appliance operates.

### Activating and deactivating the Function Lock function:

1. Activate the appliance.
2. Activate an oven function or setting.
3. Press and hold  and  at the same time for 2 seconds.
4. An acoustic signal sounds. Loc comes on / goes out on the display (when you activate or deactivate the Function Lock).

 You can deactivate the appliance when the Function Lock is on. When you deactivate the appliance, the Function Lock deactivates. Loc comes on in the display when you turn a knob or press a button.

Temperature	Switch-off time
30 °C - 115 °C	12.5 h
120 °C - 195 °C	8.5 h
200 °C - 230 °C	5.5 h

**Important!** The automatic switch-off works with all functions except Light, Duration and End Time.

## Helpful hints and tips

 The temperature and baking times in the tables are guidelines only. They depend on the recipes and the quality and quantity of the ingredients used.

### Baking

#### General instructions

- Your new oven can bake or roast differently to the appliance you had before. Adapt your usual settings (temperature, cooking times) and shelf positions to the values in the tables.
- With longer baking times, you can deactivate the oven approximately 10 minutes before the

## Residual heat indicator

The display shows the residual heat indicator  when the appliance is off and the temperature in the oven is more than 40 °C. Use the temperature knob to see the oven temperature.

## Cooling fan

When the appliance operates, the cooling fan activates automatically to keep the surfaces of the appliance cool. If you deactivate the appliance, the cooling fan can continue to operate until the appliance cools down.

## Automatic switch-off

For safety reasons the appliance deactivates after some time:

- If a heating function operates.
- If you do not change the oven temperature.

end of the baking time and then use the residual heat.

**When you cook frozen food, the trays in the oven can twist during baking. When the trays become cold again, the distortions are gone.**

### How to use the Baking Tables

- The manufacturer recommends that you use the lower temperature the first time.
- If you cannot find the settings for a special recipe, look for the one that is almost the same.

- You can extend baking times by 10 – 15 minutes if you bake cakes on more than one level.
- Cakes and pastries at different heights do not always brown equally at first. If this occurs,

do not change the temperature setting. The differences equalize during the baking procedure.

## Tips on baking

Baking results	Possible cause	Remedy
The bottom of the cake is not browned sufficiently.	The shelf position is incorrect.	Put the cake on a lower shelf.
The cake sinks and becomes soggy, lumpy or streaky.	The oven temperature is too high.	The next time you bake, set a slightly lower oven temperature.
The cake sinks and becomes soggy, lumpy or streaky.	The baking time is too short.	Set a longer baking time. <b>You cannot decrease baking times by setting higher temperatures.</b>
The cake sinks and becomes soggy, lumpy or streaky.	There is too much liquid in the mixture.	Use less liquid. Be careful with mixing times, especially if you use a mixing machine.
The cake is too dry.	The oven temperature is too low.	The next time you bake, set a higher oven temperature.
The cake is too dry.	The baking time is too long.	The next time you bake, set a shorter baking time.
The cake browns unevenly.	The oven temperature is too high and the baking time is too short.	Set a lower oven temperature and a longer baking time.
The cake browns unevenly.	The mixture is unevenly distributed.	Spread the mixture evenly on the baking tray.
The cake is not ready in the baking time given.	The oven temperature is too low.	The next time you bake, set a slightly higher oven temperature.

## Baking on one oven level

### General instructions

- Your new oven may bake or roast differently to the appliance you had before. Adapt your usual settings (temperature, cooking times) and shelf levels to the values in the tables.

With longer baking times, the oven can be switched off about 10 minutes before the end of baking time, to use the residual heat.

When you use frozen food, the trays in the oven can twist during baking. When the trays get cold again, the distortion will be gone.

## How to use the Baking Tables

- We recommend to use the lower temperature the first time.

If you cannot find the settings for a special recipe, look for the one that is almost the same. Baking time can be extended by 10 - 15 minutes, if you bake cakes on more than one level. Cakes and pastries at different heights do not always brown equally at first. If this occurs, do not change the temperature setting. The differences equalize during the baking procedure.

## Baking in tins

Type of baking	Oven function	Shelf position	Temperature (°C)	Time (min)
Ring cake or brioche	True Fan Cooking	2	150 - 160	50 - 70
Madeira cake / Fruit cakes	True Fan Cooking	2	140 - 160	70 - 90
Sponge cake / Sponge cake	True Fan Cooking	2	140 - 150	35 - 50
Sponge cake / Sponge cake	Conventional Cooking	2	160	35 - 50
Flan base - short pastry <sup>1)</sup>	True Fan Cooking	2	170 - 180	10 - 25
Flan base - sponge mixture	True Fan Cooking	2	150 - 170	20 - 25
Apple pie / Apple pie (2 tins Ø 20 cm, diagonally off set)	True Fan Cooking	2	160	70 - 90
Apple pie / Apple pie (2 tins Ø 20 cm, diagonally off set)	Conventional Cooking	1	180	70 - 90
Cheesecake, tray <sup>2)</sup>	Conventional Cooking	1	160 - 170	60 - 90

1) Preheat the oven.

2) Use the deep pan.

## Cakes / pastries / breads on baking trays

Type of baking	Oven function	Shelf position	Temperature (°C)	Time (min)
Plaited bread / bread crown	Conventional Cooking	2	170 - 190	30 - 40
Christmas stollen <sup>1)</sup>	Conventional Cooking	2	160 - 180	50 - 70
Bread (rye bread) <sup>1)</sup>	Conventional Cooking	2		
first of all			230	20
then			160 - 180	30 - 60
Cream puffs / eclairs <sup>1)</sup>	Conventional Cooking	2	190 - 210	20 - 35
Swiss Roll <sup>1)</sup>	Conventional Cooking	2	180 - 200	10 - 20
Cake with crumble topping (dry)	True Fan Cooking	3	150 - 160	20 - 40
Buttered almond cake / sugar cakes <sup>1)</sup>	Conventional Cooking	2	190 - 210	20 - 30
Fruit flans (made with yeast dough / sponge mixture) <sup>2)</sup>	True Fan Cooking	3	150 - 160	35 - 55
Fruit flans (made with yeast dough / sponge mixture) <sup>2)</sup>	Conventional Cooking	1	170	35 - 55
Fruit flans made with short pastry	True Fan Cooking	3	160 - 170	40 - 80



Type of baking	Oven function	Shelf position	Temperature (°C)	Time (min)
Yeast cakes with delicate toppings (e.g. quark, cream, custard) <sup>1)</sup>	Conventional Cooking	2	160 - 180	40 - 80

## Biscuits

Food	Oven function	Shelf position	Temperature (°C)	Time (min)
Short pastry biscuits	True Fan Cooking	3	150 - 160	10 - 20
Short bread / Short bread / Pastry Stripes	True Fan Cooking	3	140	20 - 35
Short bread / Short bread / Pastry Stripes <sup>1)</sup>	Conventional Cooking	2	160	20 - 30
Biscuits made with sponge mixture	True Fan Cooking	2	150 - 160	15 - 20
Pastries made with egg white, meringues	True Fan Cooking	1	80 - 100	120 - 150
Macaroons	True Fan Cooking	3	100 - 120	30 - 50
Biscuits made with yeast dough	True Fan Cooking	3	150 - 160	20 - 40
Puff pastries <sup>1)</sup>	True Fan Cooking	3	170 - 180	20 - 30
Rolls <sup>1)</sup>	Conventional Cooking	2	190 - 210	10 - 25
Small cakes / Small cakes <sup>1)</sup>	True Fan Cooking	3	160	20 - 35
Small cakes / Small cakes <sup>1)</sup>	Conventional Cooking	2	170	20 - 35

## Multileveled baking

### Cakes / pastries / breads on baking trays

Type of baking	True Fan Cooking Shelf positions from bottom 2 shelf positions	Temperature (°C)	Time (min)
Cream puffs / Eclairs <sup>1)</sup>	1 / 3	160 - 180	25 - 45
Dry streusel cake	1 / 3	150 - 160	30 - 45

<sup>1)</sup> Preheat the oven.

### Biscuits / small cakes / pastries / rolls

Type of baking	True Fan Cooking Shelf positions from bottom 2 shelf positions	Temperature (°C)	Time (min)
Short pastry biscuits	1 / 3	150 - 160	20 - 40

Type of baking	True Fan Cooking Shelf positions from bottom 2 shelf positions	Temperature (°C)	Time (min)
Short bread / Short bread / Pastry Stripes	1 / 3	140	25 - 45
Biscuits made with sponge mixture	1 / 3	160 - 170	25 - 40
Pastries made with egg white, meringues	1 / 3	80 - 100	130 - 170
Macaroons	1 / 3	100 - 120	40 - 80
Biscuits made with yeast dough	1 / 3	160 - 170	30 - 60

## Pizza Setting

Type of baking	Shelf position	Temperature (°C)	Time (min)
Pizza (thin crust) <sup>1)</sup>	3	200 - 230	15 - 20
Pizza (with a lot of topping) <sup>2)</sup>	3	180 - 200	20 - 30
Tarts	3	180 - 200	40 - 55
Spinach flan	3	160 - 180	45 - 60
Quiche Lorraine (Savoury flan)	3	170 - 190	45 - 55
Swiss Flan	3	170 - 190	45 - 55
Cheesecake	2	140 - 160	60 - 90
Apple cake, covered	2	150 - 170	50 - 60
Vegetable pie	3	160 - 180	50 - 60
Unleavened bread <sup>1)</sup>	3	230	10 - 20
Puff pastry flan <sup>1)</sup>	3	160 - 180	45 - 55
Flammekuchen <sup>1)</sup>	3	230	12 - 20
Piroggen (Russian version of calzone) <sup>1)</sup>	3	180 - 200	15 - 25

1) Preheat the oven.

2) Use the deep pan.

## Roasting table

### Roasting dishes

- Large roasting joints can be roasted directly in the deep pan or on the wire shelf above the deep pan (if present).
- Roast lean meats in a roasting tin with a lid. This will keep the meat more succulent.

- All types of meat, that can be browned or have crackling, can be roasted in the roasting tin without the lid.
- Use heat-resistant ovenware to roast (refer to the instructions of the manufacturer).
- You can roast large roasting joints directly in the deep pan (if present) or on the wire shelf above the deep pan.

- Roast lean meats in the roasting tin with the lid. This keeps the meat more succulent.
  - All types of meat that can be browned or have crackling can be roasted in the roasting tin without the lid.
  - We recommend that you cook meat and fish weighing 1 kg and above in the oven.
  - To prevent the meat juices or fat from burning onto the pan, put some liquid into the deep pan.
- If necessary, turn the roast (after 1 / 2 - 2 / 3 of the cooking time).
  - Baste large roasts and poultry with their juices several times during roasting. This gives better roasting results.
  - You can deactivate the appliance approximately 10 minutes before the end of the roasting time, and use the residual heat.

## Beef

Type of meat	Quantity	Oven function	Shelf position	Temperature (°C)	Time (min)
Pot roast	1 - 1.5 kg	Conventional Cooking	1	230	120 - 150
Roast beef or fillet					
rare	per cm of thickness	Turbo Grilling	1	190 - 200 <sup>1)</sup>	5 - 6 per cm of thickness
medium	per cm of thickness	Turbo Grilling	1	180 - 190	6 - 8 per cm of thickness
well done	per cm of thickness	Turbo Grilling	1	170 - 180	8 - 10 per cm of thickness

1) Preheat the oven.

## Pork

Type of meat	Quantity	Oven function	Shelf position	Temperature (°C)	Time (min)
Shoulder, neck, ham joint	1 - 1.5 kg	Turbo Grilling	1	160 - 180	90 - 120
Chop, spare rib	1 - 1.5 kg	Turbo Grilling	1	170 - 180	60 - 90
Meat loaf	750 g - 1 kg	Turbo Grilling	1	160 - 170	50 - 60
Pork knuckle (precooked)	750 g - 1 kg	Turbo Grilling	1	150 - 170	90 - 120

## Veal

Type of meat	Quantity	Oven function	Shelf position	Temperature (°C)	Time (min)
Roast veal	1 kg	Turbo Grilling	1	160 - 180	90 - 120
Knuckle of veal	1.5 - 2 kg	Turbo Grilling	1	160 - 180	120 - 150

## Lamb

Type of meat	Quantity	Oven function	Shelf position	Temperature (°C)	Time (min)
Leg of lamb, roast lamb	1 - 1.5 kg	Turbo Grilling	1	150 - 170	100 - 120
Saddle of lamb	1 - 1.5 kg	Turbo Grilling	1	160 - 180	40 - 60

## Game

Type of meat	Quantity	Oven function	Shelf position	Temperature (°C)	Time (min)
Saddle of hare, leg of hare <sup>1)</sup>	up to 1 kg	Conventional Cooking	1	230	30 - 40
Saddle of venison	1.5 - 2 kg	Conventional Cooking	1	210 - 220	35 - 40
Haunch of venison	1.5 - 2 kg	Conventional Cooking	1	180 - 200	60 - 90

## Poultry

Type of meat	Quantity	Oven function	Shelf position	Temperature (°C)	Time (min)
Chicken, spring chicken	200 - 250 g each	Turbo Grilling	1	200 - 220	30 - 50
Chicken half	400 - 500 g each	Turbo Grilling	1	190 - 210	35 - 50
Poultry pieces	1 - 1.5 kg	Turbo Grilling	1	190 - 210	50 - 70
Duck	1.5 - 2 kg	Turbo Grilling	1	180 - 200	80 - 100

## Fish (steamed)

Type of meat	Quantity	Oven function	Shelf position	Temperature (°C)	Time (min)
Whole fish	1 - 1.5 kg	Conventional Cooking	1	210 - 220	40 - 60

### Grilling

Always grill with the maximum temperature setting.

 **Caution!** Always grill with the oven door closed.

 Always preheat the empty oven with the grill functions for 5 minutes.

- Set the shelf in the shelf level as recommended in the grilling table.
- Always set the pan to collect the fat into the first shelf level.
- Grill only flat pieces of meat or fish.

### Grilling

Food to be grilled	Temperature (°C)	Oven level	Grilling time (min)	
			1st side	2nd side
Roast beef, medium	210 - 230	1	30 - 40	30 - 40
Filet of beef, medium	230	1	20 - 30	20 - 30
Back of pork	210 - 230	1	30 - 40	30 - 40
Back of veal	210 - 230	1	30 - 40	30 - 40
Back of lamb	210 - 230	1	25 - 35	20 - 35
Whole Fish, 500 - 1000 g	210 - 230	1	15 - 30	15 - 30

## Fast Grilling

Food to be grilled <sup>1)</sup>	Oven level	Grilling time (min)	
		1st side	2nd side
Burgers / Burgers	3	9 - 13	8 - 10
Pork fillet	2	10 - 12	6 - 10
Sausages	3	10 - 12	6 - 8
Fillet steaks, veal steaks	3	7 - 10	6 - 8
Toast / Toast	3	1 - 3	1 - 3
Toast with topping	2	6 - 8	-

1) Preheat the oven.

### Defrosting

- Remove the food packaging. Put the food on a plate.
- Do not cover it with a bowl or a plate. This can extend the defrost time.

- Use the first oven shelf level. The one on the bottom.

## Defrosting table

Food	Quantity	Defrosting time in min	Further defrosting time in min	Comment
Chicken	1 kg	100 - 140	20 - 30	Put the chicken on an upturned saucer in a big plate. Turn halfway through
Meat	1 kg	100 - 140	20 - 30	Turn halfway through
Meat	0,5 kg	90 - 120	20 - 30	Turn halfway through
Trout	150 g	25 - 35	10 - 15	---
Strawberries	300 g	30 - 40	10 - 20	---
Butter	250 g	30 - 40	10 - 15	---

Food	Quantity	Defrosting time in min	Further defrosting time in min	Comment
Cream	2 x 200 g	80 - 100	10 - 15	Whip the cream when still slightly frozen in places
Gateau	1,4 kg	60	60	---

### Making preserves - Bottom Heat

Oven function: Bottom heat

- Use only preserve jars of the same dimensions available on the market.
- Do not use jars with twist-off and bayonet type lids, or metal tins.
- Use the first shelf from the bottom for this function.
- Put no more than six one-litre preserve jars on the baking tray.

- Fill the jars up to the same level and close with a clamp.
- The jars cannot touch each other.
- Put approximately 1 / 2 litre of water into the baking tray to give sufficient moisture in the oven.
- When the liquid in the jars starts to simmer (after approx. 35 - 60 minutes with one-litre jars), stop the oven or decrease the temperature to 100 °C (see the table).

### Preserves table - Soft Fruits

Preserve	Temperature (°C)	Cooking time until simmering (min)	Cooking time at 100 °C (min)
Strawberries, blueberries, raspberries, ripe gooseberries	160 - 170	35 - 45	---

### Preserves table - Stone fruits

Preserve	Temperature (°C)	Cooking time until simmering (min)	Cooking time at 100 °C (min)
Pears, quinces, plums	160 - 170	35 - 45	10 - 15

### Preserves table - Vegetables

Preserve	Temperature (°C)	Cooking time until simmering (min)	Cooking time at 100 °C (min)
Carrots <sup>1)</sup>	160 - 170	50 - 60	5 - 10
Cucumbers	160 - 170	50 - 60	---
Mixed pickles	160 - 170	50 - 60	15
Kohlrabi, peas, asparagus	160 - 170	50 - 60	15 - 20

1) Keep in the oven after you stop the oven

### Drying

Oven function: True Fan Cooking

Food	Temperature (°C)	Shelf position	Time (h)
Beans	60 - 70	3	6 - 8
Peppers	60 - 70	3	5 - 6
Vegetables for soup	60 - 70	3	5 - 6
Mushrooms	50 - 60	3	6 - 8
Herbs	40 - 50	3	2 - 3
Plums	60 - 70	3	8 - 10
Apricots	60 - 70	3	8 - 10
Apple slices	60 - 70	3	6 - 8
Pears	60 - 70	3	6 - 9

### Tips for the microwave

Result	Remedy
You cannot find details for the amount of food prepared.	Look for a similar food. Increase or shorten the length of the cooking times according to the following rule: <b>Double the amount = almost double the time</b> <b>Half the amount = half the time</b>
The food has got too dry.	Set shorter cooking time or select lower microwave power.
The food is still not defrosted, hot or cooked after the time has elapsed.	Set longer cooking time or select higher microwave power. Please note that taller dishes need longer.
After the cooking time has elapsed, the food is overheated at the edge but is still not ready in the middle.	Next time select a lower power and a longer time. Stir liquids, e. g. soup, halfway through.

### Microwave Cooking Table

#### Defrosting meat

Food	Weight (g)	Power (Watts)	Microwave		Comments
			Time (min)	Standing time (min)	
Whole cuts of meat	500	200	10 - 12	10 - 15	Turn halfway through
Steak	200	200	3 - 5	5 - 10	Turn halfway through; remove defrosted parts
Mixed minced meat	500	200	10 - 15	10 - 15	Turn halfway through; remove defrosted parts
Goulash	500	200	10 - 15	10 - 15	Turn halfway through; remove defrosted parts

#### Defrosting poultry

Food	Weight (g)	Power (Watts)	Microwave		Comments
			Time (min)	Standing time (min)	
Chicken	1000	200	25 - 30	10 - 20	Turn halfway through; cover defrosted parts with aluminium foil
Chicken breast	100 - 200	200	3 - 5	10 - 15	Turn halfway through; cover defrosted parts with aluminium foil
Chicken thighs	100 - 200	200	3 - 5	10 - 15	Turn halfway through; cover defrosted parts with aluminium foil
Duck	2000	200	45 - 60	20 - 30	Turn halfway through; cover defrosted parts with aluminium foil

## Defrosting fish

Food	Weight (g)	Power (Watts)	Microwave		Comments
			Time (min)	Standing time (min)	
Whole Fish	500	100	10 - 15	15 - 20	Turn halfway through
Fish fillets	500	100	10 - 12	15 - 20	Turn halfway through

## Defrosting sausage

Food	Weight (g)	Power (Watts)	Microwave		Comments
			Time (min)	Standing time (min)	
Sliced sausage	100	100	2 - 4	20 - 40	Turn halfway through

## Defrosting dairy products

Food	Weight (g)	Power (Watts)	Microwave		Comments
			Time (min)	Standing time (min)	
Quark	250	100	10 - 15	25 - 30	Remove aluminium parts, turn halfway through
Butter	250	100	3 - 5	15 - 20	Remove aluminium parts, turn halfway through
Cheese	250	100	3 - 5	30 - 60	Remove aluminium parts, turn halfway through
Cream	200	100	7 - 12	20 - 30	Remove aluminium top, stir halfway through

## Defrosting cakes / pastries



Food	Microwave				
	Weight (g)	Power (Watts)	Time (min)	Standing time (min)	Comments
Yeast dough	1 piece	100	2 - 3	15 - 20	Turn plate halfway through
Cheesecake	1 piece	100	2 - 4	15 - 20	Turn plate halfway through
Cake (gateau)	1 piece	100	1 - 2	15 - 20	Turn plate halfway through
Dry cake (e. g. Pound cake)	1 piece	100	2 - 4	15 - 20	Turn plate halfway through
Fruit cake	1 piece	100	1 - 2	15 - 20	Turn plate halfway through
Bread	1000	100	15 - 20	10 - 15	Turn halfway through
Sliced bread	500	100	8 - 12	10 - 15	Turn halfway through
Bread rolls	4 rolls	100	5 - 8	5 - 10	Turn halfway through

## Defrosting Fruit

Food	Microwave				
	Weight (g)	Power (Watts)	Time (min)	Standing time (min)	Comments
Strawberries	300	100	8 - 12	10 - 15	Defrost covered, stir half-way through
Plums, cherries, raspberries, blackcurrants, apricots	250	100	8 - 10	10 - 15	Defrost covered, stir half-way through

## Cooking / Melting

Food	Microwave				
	Weight (g)	Power (Watts)	Time (min)	Standing time (min)	Comments
Chocolate / Chocolate coating	150	600	2 - 3	---	Stir halfway through
Butter	100	200	2 - 4	---	Stir halfway through

## Defrosting heating

Food	Microwave				
	Weight (g)	Power (Watts)	Time (min)	Standing time (min)	Comments
Baby food in jars	200	300	2 - 3	---	Stir halfway through; check temperature!
Baby milk (bottle, 180 ml)	200	1000	0:20 - 0:40	---	Put spoon into bottle, stir and check temperature!

Food	Microwave				
	Weight (g)	Power (Watts)	Time (min)	Standing time (min)	Comments
Convenience food	400 - 500	600	4 - 6	5	Remove any aluminium lids, turn halfway through
Frozen ready meals	400 - 500	400	14 - 20	5	Remove any aluminium lids, turn halfway through
Milk	1 cup approx. 200 ml	1000	1:15 - 1:45	---	Put spoon in the container
Water	1 cup approx. 200 ml	1000	1:30 - 2	---	Put spoon in the container
Sauce	200 ml	600	1 - 2	---	Stir halfway through
Soup	300 ml	600	2 - 4	---	Stir halfway through

## Cooking table

Food	Microwave				
	Weight (g)	Power (Watts)	Time (min)	Standing time (min)	Comments
Whole fish	500	500	8 - 10	---	Cook covered, turn container several times during cooking
Fish fillets	500	500	6 - 8	---	Cook covered, turn container several times during cooking
Vegetables, short cooking time, fresh <sup>1)</sup>	500	600	12 - 16	---	Add approx. 50 ml water, cook covered, stir halfway through
Vegetables, short cooking time, frozen <sup>1)</sup>	500	600	14 - 18	---	Add approx. 50 ml water, cook covered, stir halfway through
Vegetables, long cooking time, fresh <sup>1)</sup>	500	600	14 - 20	---	Add approx. 50 ml water, cook covered, stir halfway through
Vegetables, long cooking time, frozen <sup>1)</sup>	500	600	18 - 24	---	Add approx. 50 ml water, cook covered, stir halfway through
Potatoes in their jacket	800 g + 600 ml	1000	5 - 7	300 W / 15 - 20	Cook covered, stir halfway through
Rice	300 g + 600 ml	1000	4 - 6	---	Cook covered, stir halfway through

<sup>1)</sup> Cook all vegetables with a cover on the container. The times given are guidelines only and depend upon the type and qualities of the foodstuffs.

### Combi-Function Table (for selected models only)

Preheat Crostino plate: 4 minutes at 700 Watt

Food	Baking / roasting dishes	Temp. (°C)	Micro-wave (Watt)	Shelf position	Time (min)	Comments
2 chicken halves (2 x 600 g)	Glass dish with strainer	220	300	2	40	Turn after 20 min., standing time 5 min.
au gratin potatoes (1 kg)	Gratin dish	200	300	2	40	10 min. standing time
Roast pork neck (1100 g)	Glass dish with strainer	200	300	1	70	Turn in between, 10 min. standing time
Apple cake	Crostino plate on bottom glass. with pastry max. 5 min. / preheat 1000 Watt, turn 1 x	220	400	-	25	Turn in between
Cheese cake, frozen (2 x 70 g)	Crostino plate on bottom glass. Max. 4 min. / preheat at 700 Watt, turn 1 x	230	200	-	25	Turn in between
Ham and cheese toast, frozen (2 x 100 g)	Crostino plate on bottom glass. Max. 4 min. / preheat at 700 Watt, turn 1 x	230	200	-	20	Turn after 15 min.
Hamburger frozen (2 x 90 g)	Crostino plate on bottom glass. Max. 4 min. / preheat at 700 Watt, turn 1 x	230	300	-	20	Turn after 12 min.
Pizza frozen Ø 28 cm (320 g)	Crostino plate on bottom glass. Max. 4 min. / preheat at 700 Watt, turn 1 x	230	200	-	15	Turn in between

The cooking times and temperatures are guidelines only and depend upon the type and qualities of the foodstuffs.

## Care and cleaning

 **Warning!** Refer to the Safety chapters.

### Notes on cleaning:

- Clean the front of the appliance with a soft cloth with warm water and a cleaning agent.
- To clean metal surfaces, use a usual cleaning agent.
- Clean the appliance interior after each use. Then you can remove dirt more easily and it does not burn on.
- Clean stubborn dirt with a special oven cleaner.

- Clean all accessories after each use and let them dry. Use a soft cloth with warm water and a cleaning agent.
- If you have nonstick accessories, do not clean them using aggressive agents, sharp-edged objects or a dishwasher. It can cause damage to the nonstick coating.

### Shelf support

#### Removing the shelf support

You can remove the shelf support to clean the side walls.

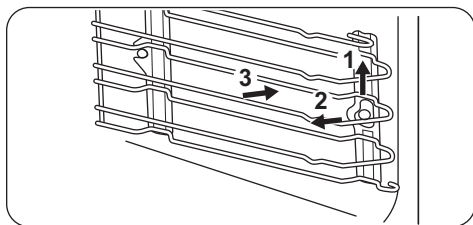

1. Carefully pull the supports up and out of the front catch.
2. Lightly move the supports on the front catch inwards.
3. Pull the supports out of the rear catch.

### Installing the shelf support

To install the shelf support follow the procedure in the opposite order.

### Lamp

**Warning!** There is a risk of electrical shock.

## What to do if...

**Warning!** Refer to the Safety chapters.

Problem	Possible cause	Remedy
The appliance does not heat up.	The appliance is deactivated.	Activate the appliance.
The appliance does not heat up.	The clock is not set.	Set the clock. Refer to "Setting the clock".
The appliance does not heat up.	The necessary settings are not set.	Make sure that the settings are correct.
The appliance does not heat up.	The automatic cut-out is activated.	Refer to "Automatic switch-off".
The appliance does not heat up.	The fuse is released.	Make sure that the fuse is the cause of the malfunction. If the fuse releases again and again, contact a qualified electrician.
The lamp does not operate.	The lamp is defective.	Replace the lamp.
The display shows an error code that is not on this list.	There is an electrical fault.	<ul style="list-style-type: none"> <li>Deactivate the appliance with the house fuse or the safety switch in the fuse box and activate it again.</li> <li>If the display shows the error code again, contact the Customer Care Department.</li> </ul>

The lamp and the lamp glass cover can be hot.

### Before you change the lamp:

- Deactivate the appliance.
- Remove the fuses from the fuse box or deactivate the circuit breaker.

**Caution!** Put a cloth on the bottom of the interior of the appliance. It prevents damage to the lamp glass cover and the cavity. Always use the same lamp type.

### Replacing the lamp at the cavity ceiling:

1. Turn the lamp glass cover counterclockwise to remove it.
2. Clean the glass cover.
3. Replace the lamp with a suitable 300 °C heat-resistant lamp.
4. Install the glass cover.

If you cannot find a solution to the problem yourself, contact your dealer or the service centre.

The necessary data for the service centre is on the rating plate. The rating plate is on the front frame of the appliance cavity.

We recommend that you write the data here:

Model (MOD.) .....  
 Product number (PNC) .....  
 Serial number (S.N.) .....

## Installation

 **Warning!** Refer to the Safety chapters.

**Important!** The built-in unit must meet the stability requirements of DIN 68930.

The oven is designed to be connected to 230 - 240V ~ (50Hz) electricity supply.

The oven has an easily accessible terminal block which is marked as follows:

Letter L - Live terminal

Letter N - Neutral terminal

 - Earth terminal

 **Caution!** This oven must be earthed!

The cable used to connect the oven to the electrical supply must comply to the specifications given below.

**For UK use only**

Connection via	Min. size Cable/flex	Cable/flex type	Fuse
Cooker Control Circuit	2,5 mm <sup>2</sup>	PVC / PVC twin and earth	min: 15 A max: 20 A

It is necessary that you install a double pole switch between the oven and the electricity supply (mains), with a minimum gap of 3 mm between the switch contacts and of a type suitable for the required load in compliance with the current regulations.

The switch must not break the yellow and green earth cable at any point.

**Important!** After installation and connecting, the cable must be placed so that it cannot at

any point reach a temperature of more than 50°C above the ambient temperature.

Before the oven is connected, check that the main fuse and the domestic installation can support the load; and that the power supply is properly earthed.

**The manufacturer declines any responsibility should these safety measures not be carried out.**

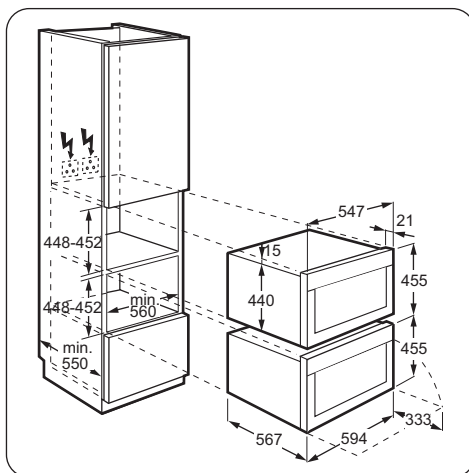
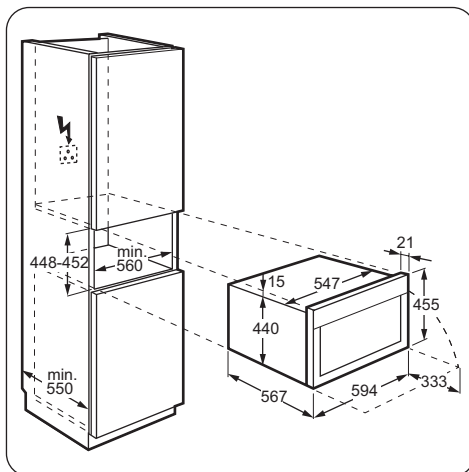

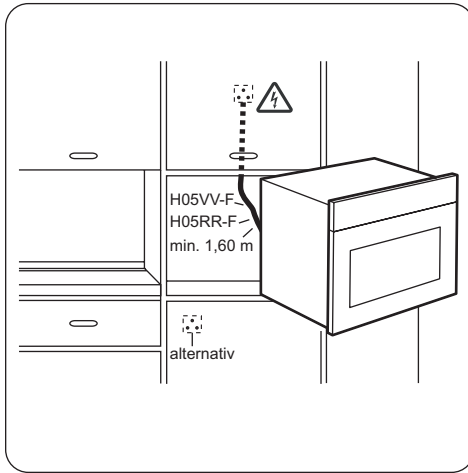
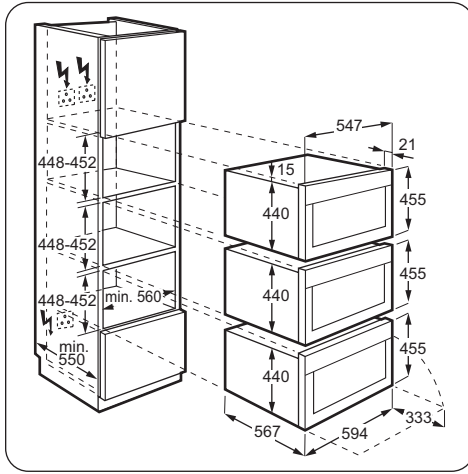

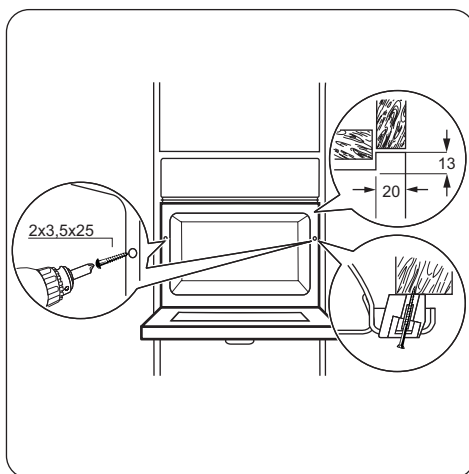
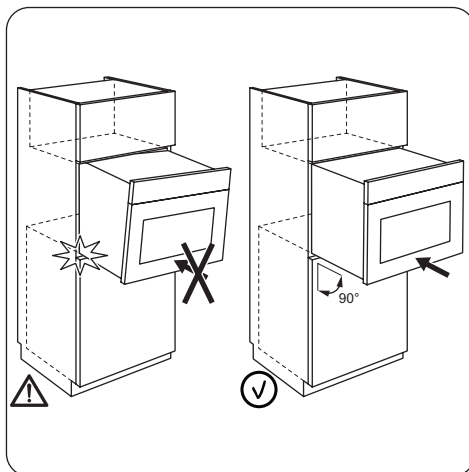

## Environment concerns

The symbol  on the product or on its packaging indicates that this product may not be treated as household waste. Instead it should be taken to the appropriate collection point for the recycling of electrical and electronic equipment. By ensuring this product is disposed of correctly, you will help prevent potential negative consequences for the environment and human health, which could otherwise be caused by inappropriate waste

handling of this product. For more detailed information about recycling of this product, please contact your local council, your household waste disposal service or the shop where you purchased the product.





### Packaging material

The packaging material is environmentally-friendly and recyclable. Plastic parts are marked

with international abbreviations such as PE, PS, etc. Dispose of the packaging material in the containers provided for this purpose at your local waste management facility.



## GREAT BRITAIN & IRELAND - Guarantee/Customer Service

### Standard guarantee conditions:

We, Electrolux, undertake that if within 12 months of the date of the purchase this Electrolux appliance or any part thereof is proved to be defective by reason only of faulty workmanship or materials, we will, at our option repair or replace the same FREE OF CHARGE for labour, materials or carriage on condition that:

- Appliance has been correctly installed and used only on the electricity supply stated on the rating plate.
- Appliance has been used for normal domestic purposes only, in accordance with manufacturer's instructions.
- Appliance hasn't been serviced, maintained, repaired, taken apart or tampered with by person not authorised by us.
- Electrolux Service Force Centre must undertake all service work under this guarantee
- Any appliance or defective part replaced shall become the Company's property.
- This guarantee is in addition to your statutory and other legal rights.

### Exclusions

- Damage, calls resulting from transport, improper use, neglect, light bulbs, removable parts of glass, plastic.
- Costs for calls to put right appliance which is improperly installed, calls to appliances outside United Kingdom.
- Appliances found to be in use within a commercial environment, plus those which are subject to rental agreements.
- Products of Electrolux manufacturer that are not marketed by Electrolux

**Service and Spare Parts.**Please contact your local Service Force Centre: **08445 616**

**616**(Call will be routed to Service Force Centre covering your postcode area). For address of local Service Force Centre and further information, please visit: **www.serviceforce.co.uk** Before calling out an engineer, please ensure you have read the details under the heading "What to do if... / Troubleshooting". When you contact the Service Force Centre you will need to give the following details: Your name, address and postcode, your telephone number, clear concise details of the fault, model and serial number of the appliance (found on the rating plate), the purchase date. Please note a valid purchase receipt or guarantee documentation is required for in guarantee service calls.

**Customer Care.**Please contact our Customer Care Department: Electrolux Major Appliances, Addington Way, Luton, Bedfordshire, LU4 9QQ or visit our website at [www.electrolux.co.uk](http://www.electrolux.co.uk)

Customer Care Department,	Tel: (Calls may be recorded for training purposes)
Electrolux	08445 613 613
AEG-Electrolux	08445 611 611
Zanussi-Electrolux	08445 612 612

### For Customer Service in The Republic of Ireland please contact us at the address below:

Electrolux Group (Irl) Ltd, Long Mile Road, Dublin 12, Republic of Ireland  
Tel: +353 (0)1 4090751, Email: [service.eid@electrolux.ie](mailto:service.eid@electrolux.ie)

## European Guarantee

**GB** This appliance is guaranteed by Electrolux in each of the countries listed at the back of this user manual, for the period specified in the appliance guarantee or otherwise by law. If you move from one of these countries to another of the countries listed, the appliance guarantee will move with you subject to the following qualifications:-

- The appliance guarantee starts from the date you first purchased the appliance which will be evidenced by production of a valid purchase document issued by the seller of the appliance.
- The appliance guarantee is for the same period and to the same extent for labour and parts as exists in your new country of resi-

dence for this particular model or range of appliances.

- The appliance guarantee is personal to the original purchaser of the appliance and cannot be transferred to another user.
- The appliance is installed and used in accordance with instructions issued by Electrolux and is only used within the home, i.e. is not used for commercial purposes.
- The appliance is installed in accordance with all relevant regulations in force within your new country of residence.

The provisions of this European Guarantee do not affect any of the rights granted to you by law.

## www.electrolux.com

		
Albania	+355 4 261 450	Rruga "Kavajës", ish-parku autobusëve, Tiranë
Belgique/België/Belgien	+32 2 7162444	Raketstraat 40, 1130 Brussel/Bruxelles
Česká Republika	+420 261 302 261	Budějovická 3, Praha 4, 140 21
Danmark	+45 70 11 74 00	Strevelinsvej 38-40, 7000 Fredericia
Deutschland	+49 180 32 26 622	Fürther Str. 246, 90429 Nürnberg
Eesti	+37 2 66 50 030	Pärnu mnt. 153, 11624 Tallinn
España	+34 902 11 63 88	Carretera M-300, Km. 29,900 Alcalá de Henares Madrid
France	08 92 68 24 33 (0.34€/min)	www.electrolux.fr
Great Britain	+44 8445 616 616	Addington Way, Luton, Bedfordshire LU4 9QQ
Hellas	+30 23 10 56 19 70	4, Limnou Str., 54627 Thessaloniki
Hrvatska	+385 1 63 23 338	Slavonska avenija 3, 10000 Zagreb
Ireland	+353 1 40 90 753	Long Mile Road Dublin 12
Italia	+39 (0) 434 558500	Corso Lino Zanussi, 30 - 33080 Porcia (PN)
Latvija	+371 67313626	Kr. Barona iela 130/2, LV-1012, Riga
Lietuva	+370 5 278 06 03	Ozo 10a, LT-08200 Vilnius
Luxembourg	+352 42 431 301	Rue de Bitbourg, 7, L-1273 Hamm
Magyarország	(06-1)467-3205 +361 252 1773	H-1142 Budapest XIV, Erzsébet Királyné útja 87

		
Nederland	+31 17 24 68 300	Vennootsweg 1, 2404 CG - Alphen aan den Rijn
Norge	+47 81 5 30 222	Risløkkvn. 2 , 0508 Oslo
Österreich	0810 955030	Herziggasse 9, 1230 Wien
Polska	+48 22 43 47 300	ul. Kolejowa 5/7, 01-217 Warszawa
Portugal	+35 12 14 40 39 39	Quinta da Fonte - Edifício Gonçalves Zarco - Q 35 -2774-518 Paço de Arcos
Romania	+40 21 451 20 30	Str. Garii Progresului 2, S4, 040671 RO
Schweiz - Suisse - Svizzera	0848 848 111	Industriestrasse 10, CH-5506 Mägenwil
Slovenija	+38 61 24 25 731	Gerbičeva ulica 110, 1000 Ljubljana
Slovensko	+421 2 32 14 13 34-5	Electrolux Slovakia s.r.o., Electrolux Domáce spotrebiče SK, Galvaniho 17/B, 821 04 Bratislava
Suomi	030 600 5200 Lankapuhelinverkosta 0,0828€/puhelu+0,032€/min Matkapuhelinverkosta 0,192€/min	
Sverige	+46 (0)771 76 76 76	Electrolux Service, S:t Göransgatan 143, S-105 45 Stockholm
Türkiye	+90 21 22 93 10 25	Tarlabası caddesi no : 35 Taksim İstanbul
Россия	8-800-200-3589	129090 Москва, Олимпийский проспект, 16, БЦ "Олимпик"
Україна	+380 44 586 20 60	04074 Київ, вул.Автозаводська, 2а, БЦ "Алкон"



[www.zanussi.com/shop](http://www.zanussi.com/shop)



892960475-A-102013